

# MOBILE HOLDER

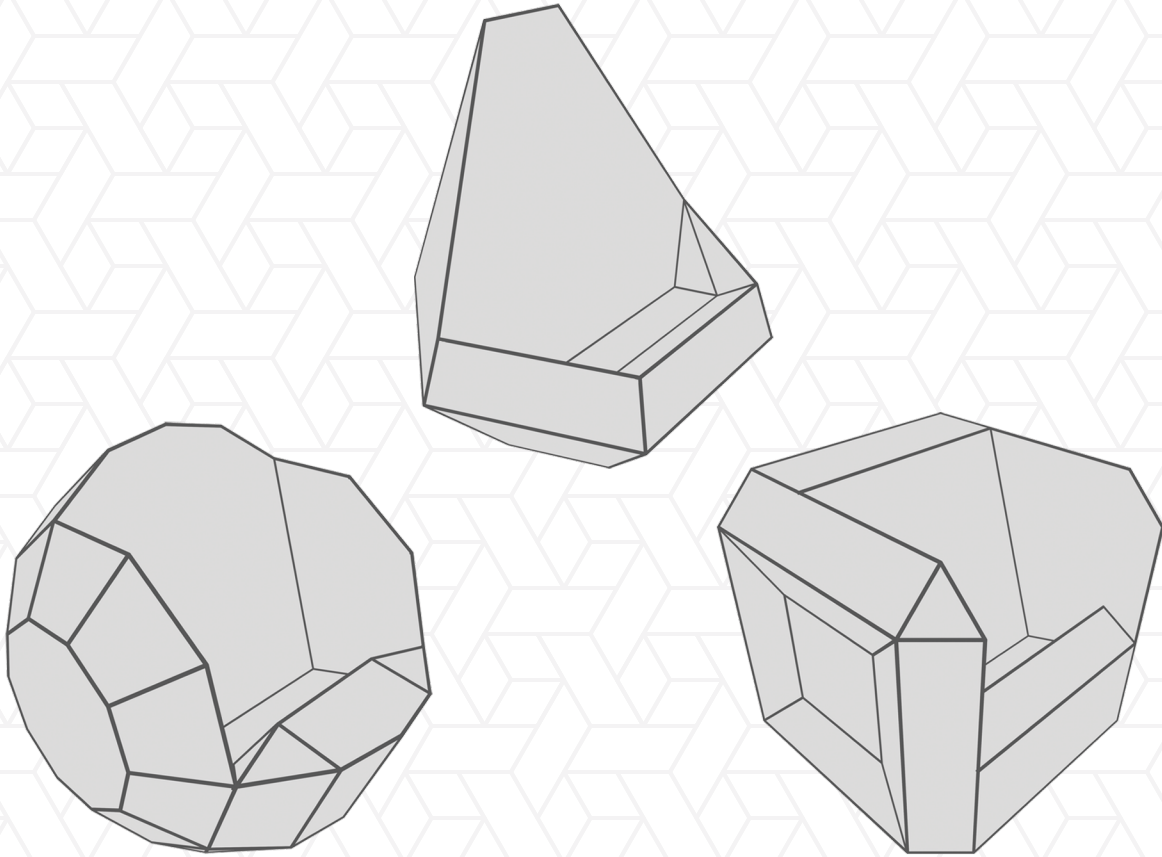

## Instrucciones de armado *Assembly instructions*

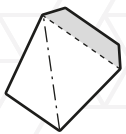

# Piezas  
# Pieces

**37**

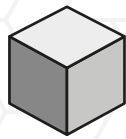

Dimensiones  
*Dimensions*

13cm x 12,5cm  
x h13,5cm



Dificultad  
*Level*

**2**



Tiempo estimado  
de armado  
*Approximate  
building time*

**2h - 3h**

**Ludikraft**

# ESPAÑOL

Este documento te guiará en la correcta forma de armar tu producto. Sigue los pasos en orden (**#1**, **#2**, **#3**, etc); cada paso te muestra la letra de la pieza a ensamblar con su respectiva imagen del ensamble (**A**, **B**, **C**, etc).

# ENGLISH

This document will guide you in the correct way to assemble your product. Remember to follow the steps in order (**#1**, **#2**, **#3**, etc); each step shows you the piece letter to be assembled with the respective image (**A**, **B**, **C**, etc).

## Antes de empezar, ten en cuenta:

- Trabaja en una superficie plana, cómoda y limpia.
- Asegúrate de tener buena iluminación.

## Before starting, keep in mind:

- Work on a flat surface, comfortable and clean.
- Have good lighting.

- Organiza las piezas por color y/o tipo de material.

- Organize the pieces by color and/or type of material.

### Partes de las piezas

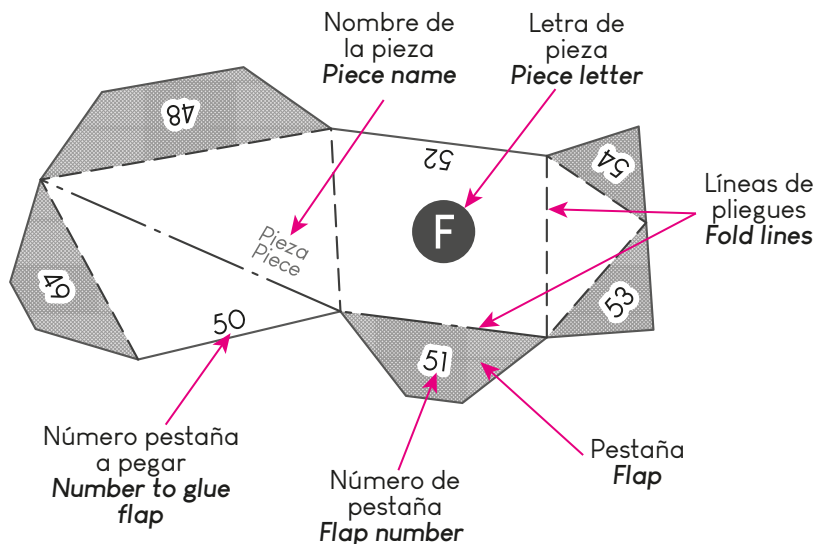

### Parts of the pieces



- Pliega las piezas por las líneas guía de dobleces (las líneas discontinuas).

Hay dos tipos de líneas de pliegue:

- Líneas Montaña**  
Son las líneas discontinuas regulares y se pliegan hacia arriba.
- Líneas Valle**  
Son las líneas discontinuas con punto y se pliegan hacia abajo.

- Fold the pieces along the fold guidelines (the dashed lines).

There are two types of folding lines:

- Mountain Lines**  
The regular dashed lines and fold up side.
- Líneas Valle**  
The dotted dashed lines and fold down side.

-----  
Líneas Montaña: las pliegas hacia arriba.  
*Mountain lines: fold up side.*

-----  
Líneas Valle: las pliegas hacia abajo.  
*Valley lines: fold down side.*

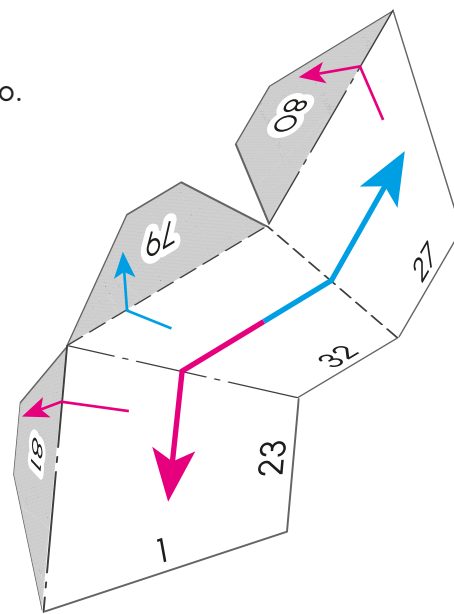
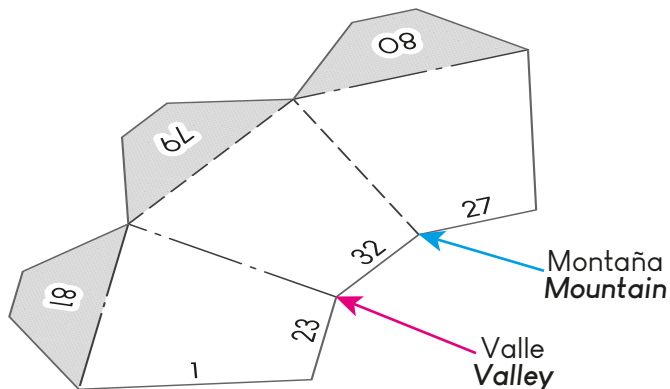

**3** Ubica las piezas según su letra y correspondientes pestañas.

**3** Locate the pieces according to their letter and corresponding flaps.

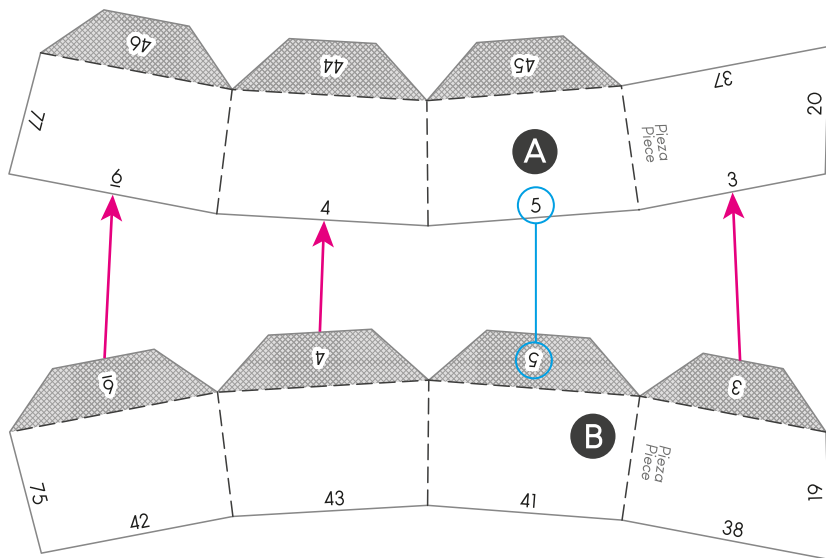

*Algunas piezas tienen pestañas que se pegan en la misma pieza.  
Some pieces have flaps that are glued on the same piece.*

**4** Aplica el adhesivo, que viene con el producto, en la parte posterior de las pestañas (la parte no impresa). No apliques demasiado pegamento y hazlo hasta cubrir los filos de la pestaña.

**4** Apply the glue, which comes with the product, on the back of the flaps (non-printed side). Do not apply too much glue, do it along the edges and make sure the flap is covered.

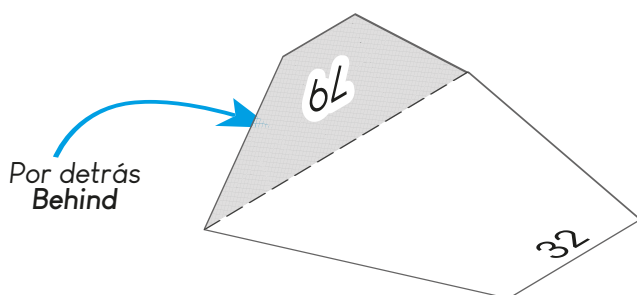

- 5 Ensambla las piezas pegando las pestañas sobre su correspondiente número. Las pestañas siempre irán al interior del producto (en la parte impresa). Asegúrate que las pestañas estén bien alineadas con los bordes de las piezas.

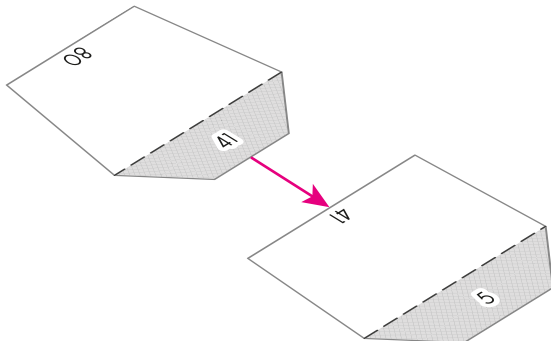

Es importante que, antes de ensamblar dos piezas, verifiques que coincidan con su correspondiente.

La *Guía de Ensamble* puede indicar pegar dos piezas primero que después armarás con el ensamble general. Tenlo presente.

## La Guía de Ensamble

Los colores de las imágenes te indicarán:



Pieza a ensamblar  
Piece to assemble



Pieza ensamblada  
Assembled piece



Pieza por ensamblar  
Piece to be assembled

## Recomendaciones

- 🔧 Trabaja sobre una superficie amplia y cómoda. Aleja cualquier líquido o material que pueda afectar el producto.
- 🔧 Mantén tus manos lo más limpias posible.
- 🔧 Asegúrate de que las pestañas coincidan con sus número antes de pegar las piezas.
- 🔧 *¡No vayas tan rápido!* Aplica el adhesivo dentro de los límites de las pestañas y ve pegando en la medida en que desarrollas el ensamble. Asegúrate muy bien de pegar correctamente cada pestaña antes de pasar a la siguiente.
- 🔧 Puedes comenzar el ensamble con las piezas más pequeñas y de acceso más complejo en el armado. Será más fácil iniciar por ahí en caso de no seguir la Guía de Ensamble.
- 🔧 Música y pausas para unos snacks harán más entretenido el armado :)

- 5 Assemble the pieces gluing the flaps with their corresponding number. The flaps will always be inside the model (onto the printed side). Make sure the flaps are well aligned with the edges of the piece.

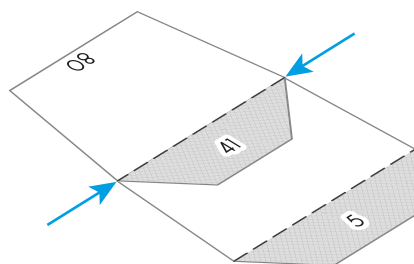

It is primary that, before assembling two pieces, you verify that they match their corresponding one.

The Assembly Guide may indicate gluing two pieces together first and then assemble them with the overall assembly. keep it in mind.

## Assembly Guide

The colors in the images will tell you:

## Recommendations

- 🔧 Work on a large and comfortable surface. Keep away liquids or any material that could affect the product.
- 🔧 Keep your hands as clean as possible.
- 🔧 Be sure the flaps coincide with their number before gluing the pieces together.
- 🔧 *Not so fast!* Apply the glue within the limits of the flaps and glue as you develop the assembly. Make sure each flap is correctly glued before moving on to the next one.
- 🔧 You can start the assembly with the smallest and most complex access parts to assemble. It will be easier to start there if you do not follow the Assembly Guide..
- 🔧 Music and breaks for snacks will make the assembly more enjoyable :)

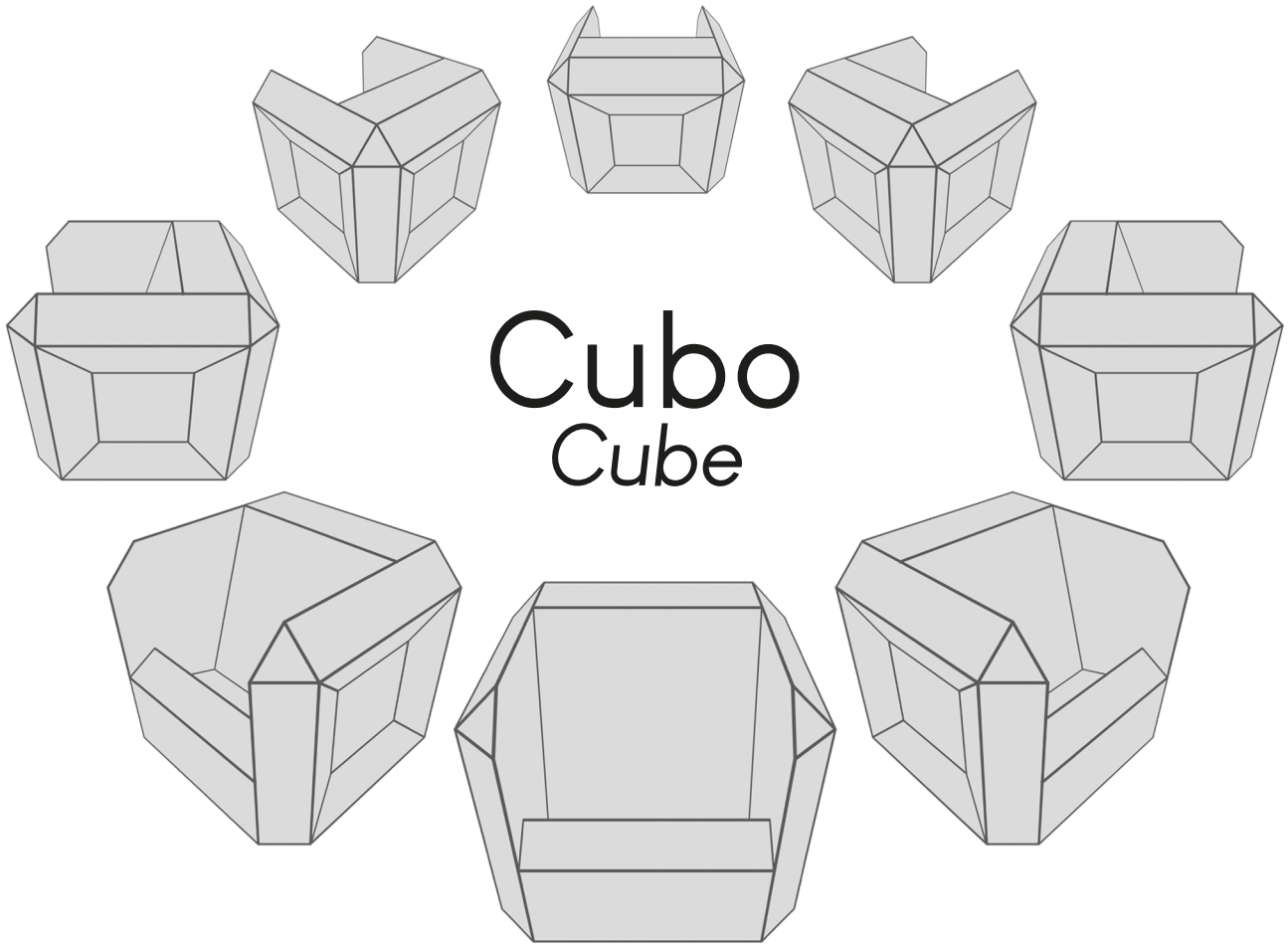

# Cubo Cube

#1

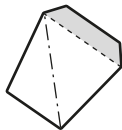
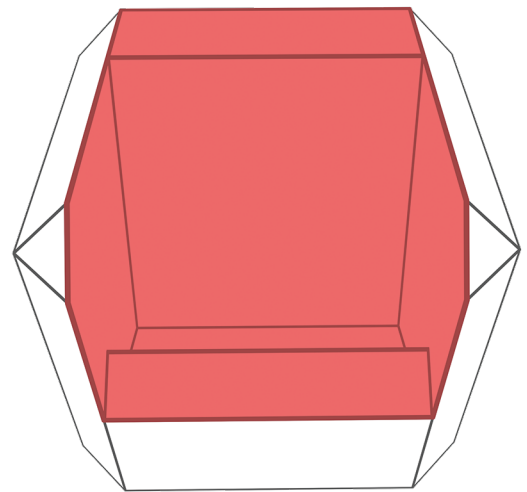
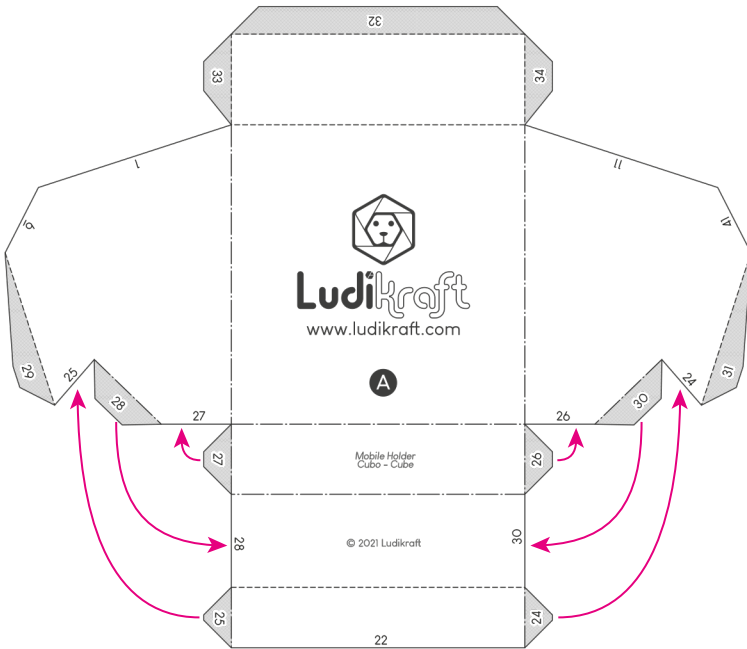

16 piezas - 16 pieces



1h

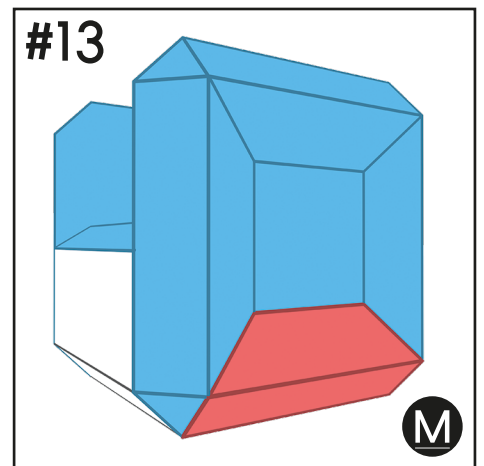
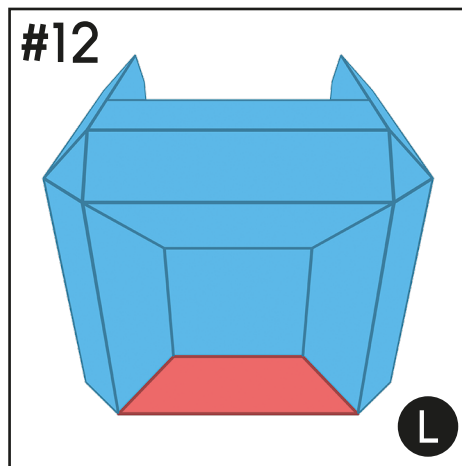
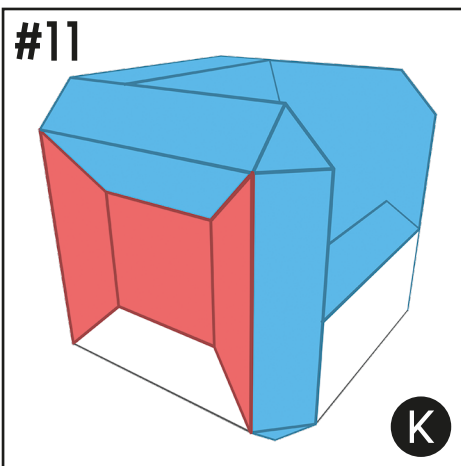
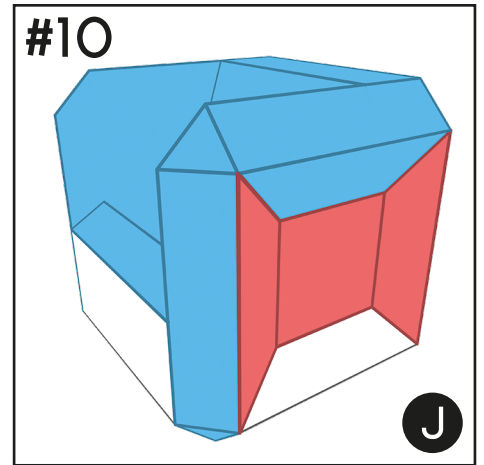
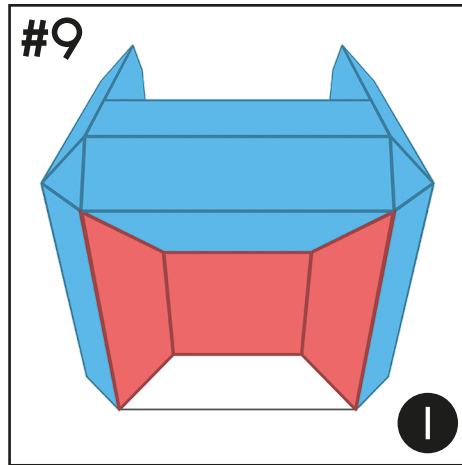
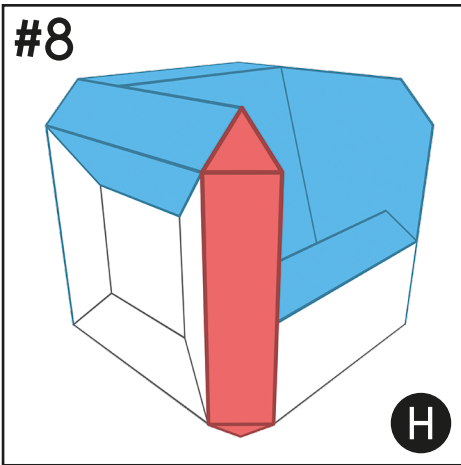
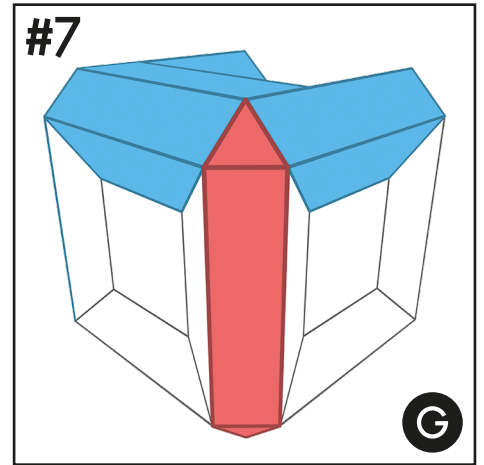
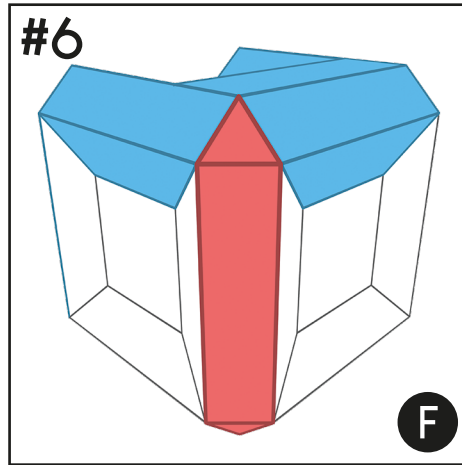
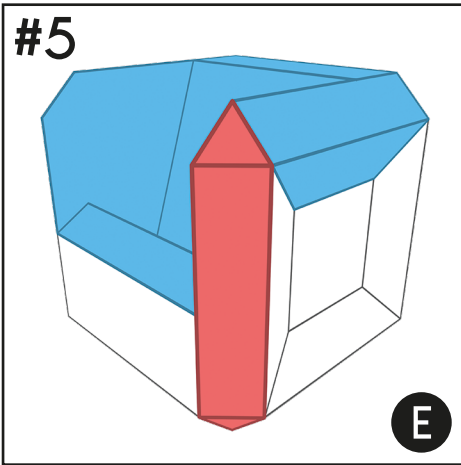
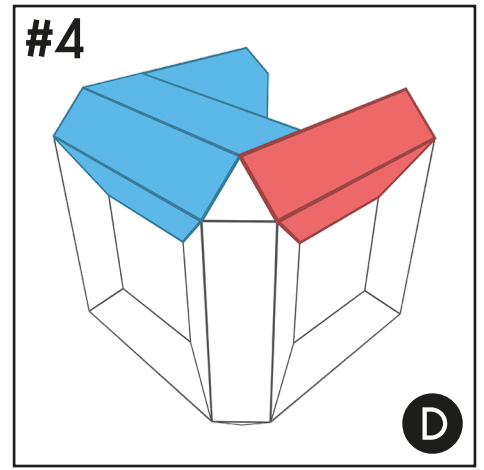
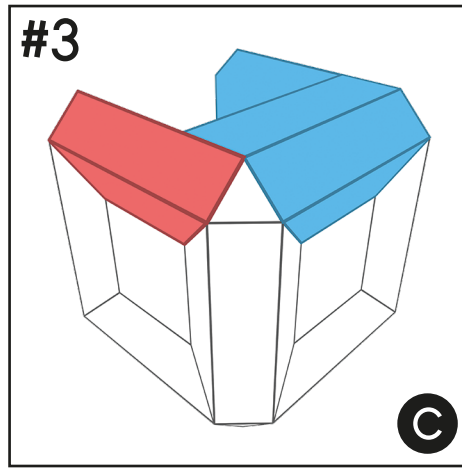
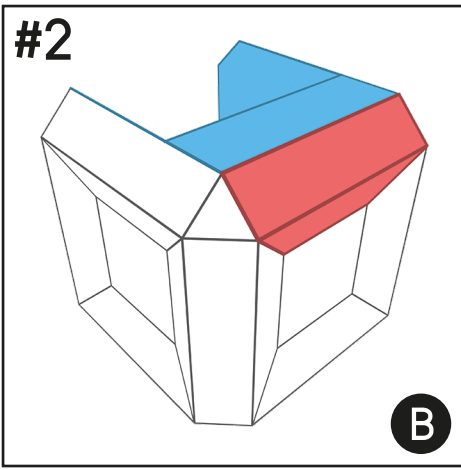

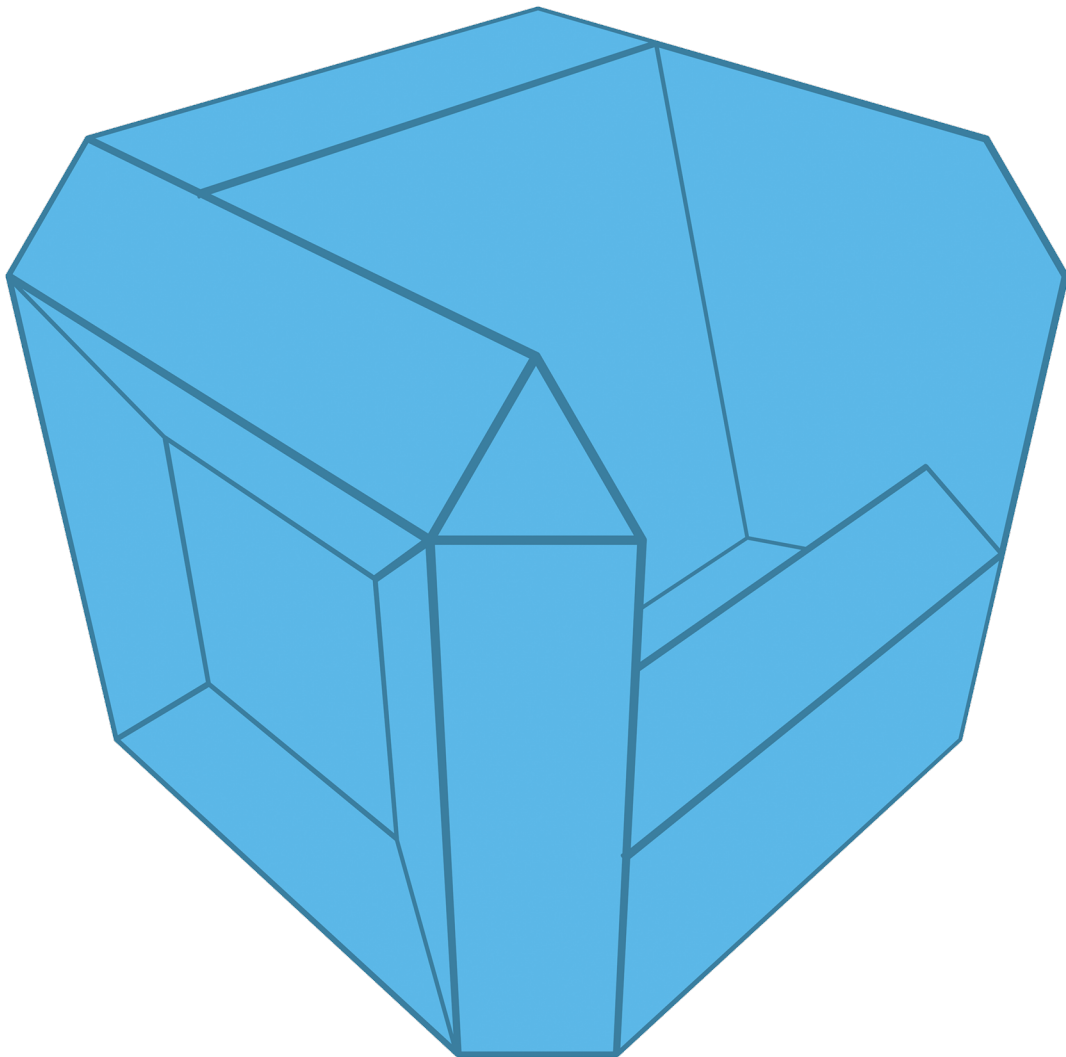
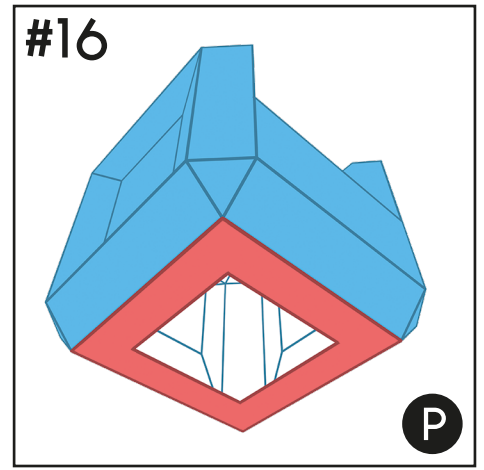
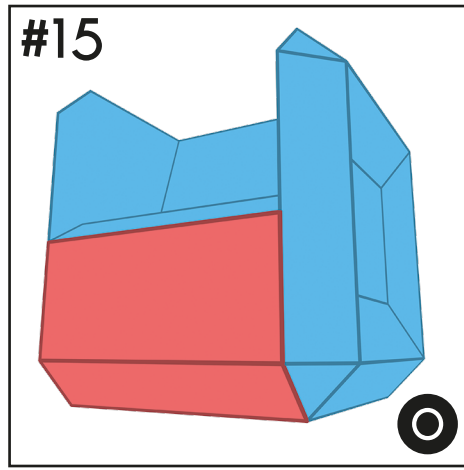
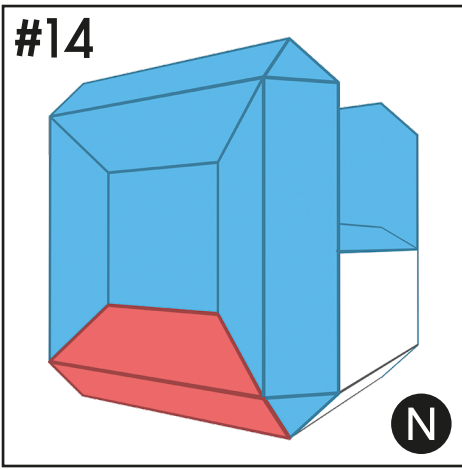

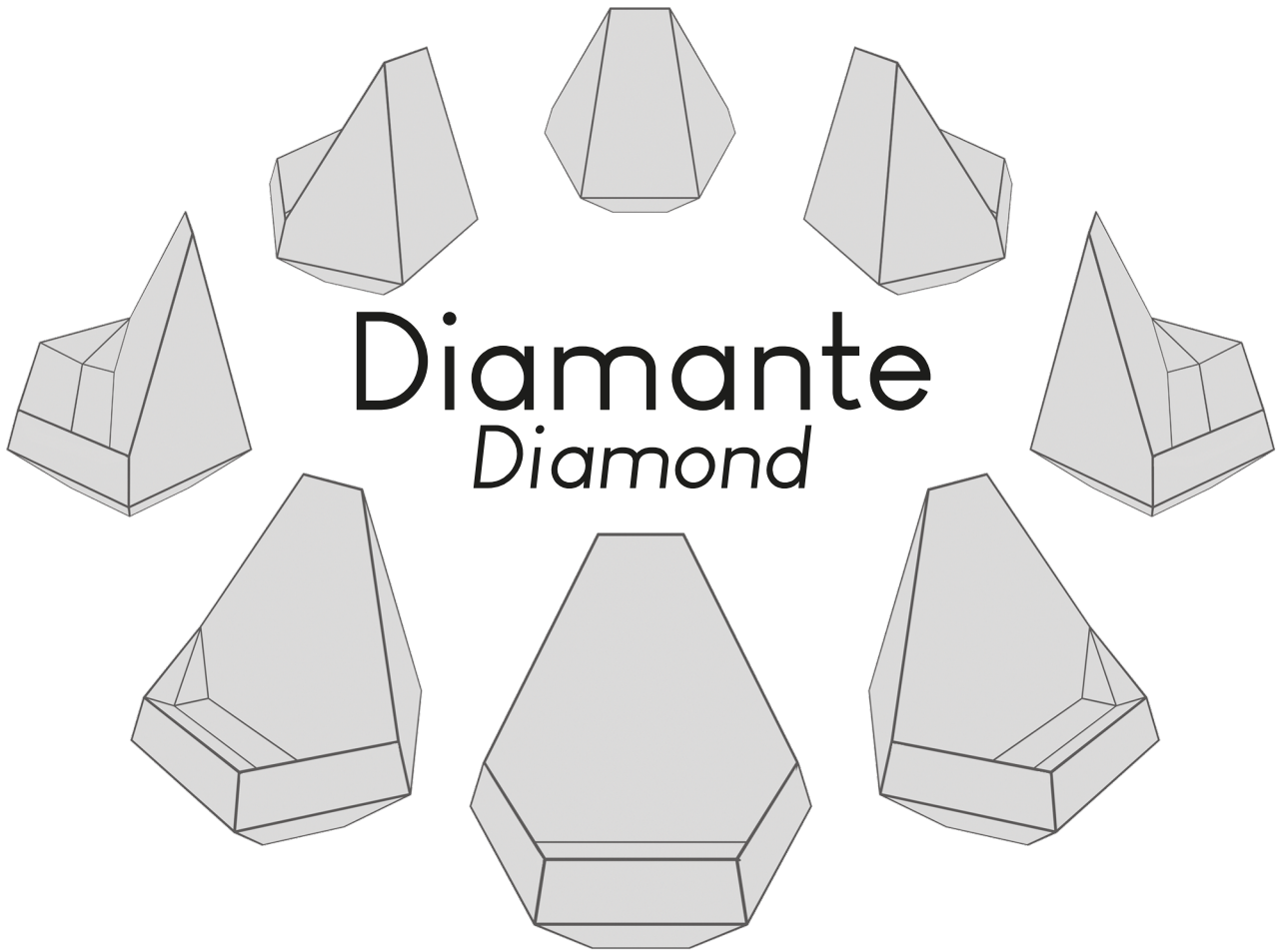

# Diamante

## Diamond

#1

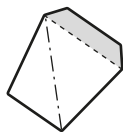
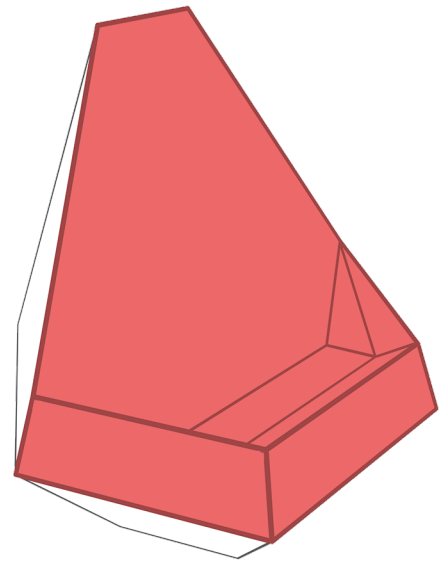
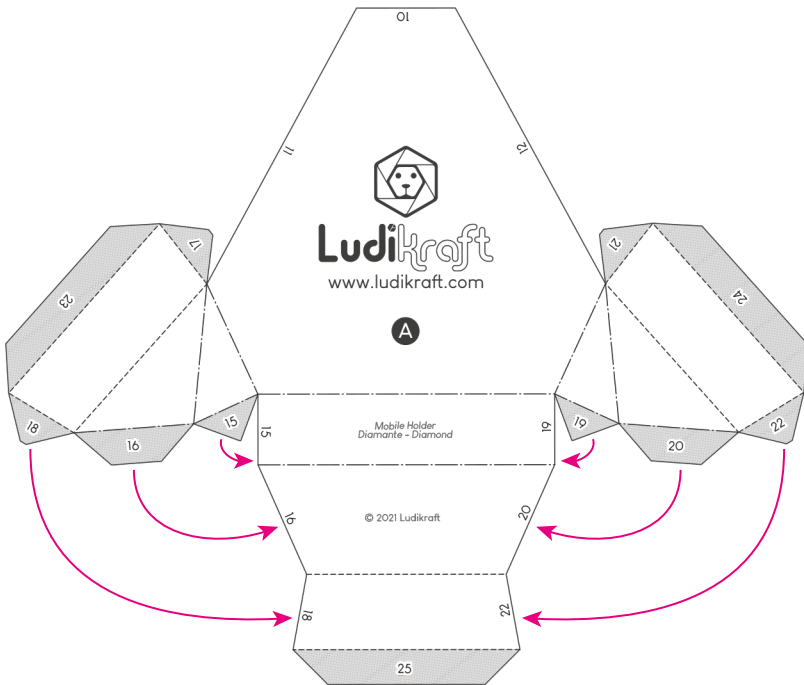

5 piezas - 5 pieces



30min



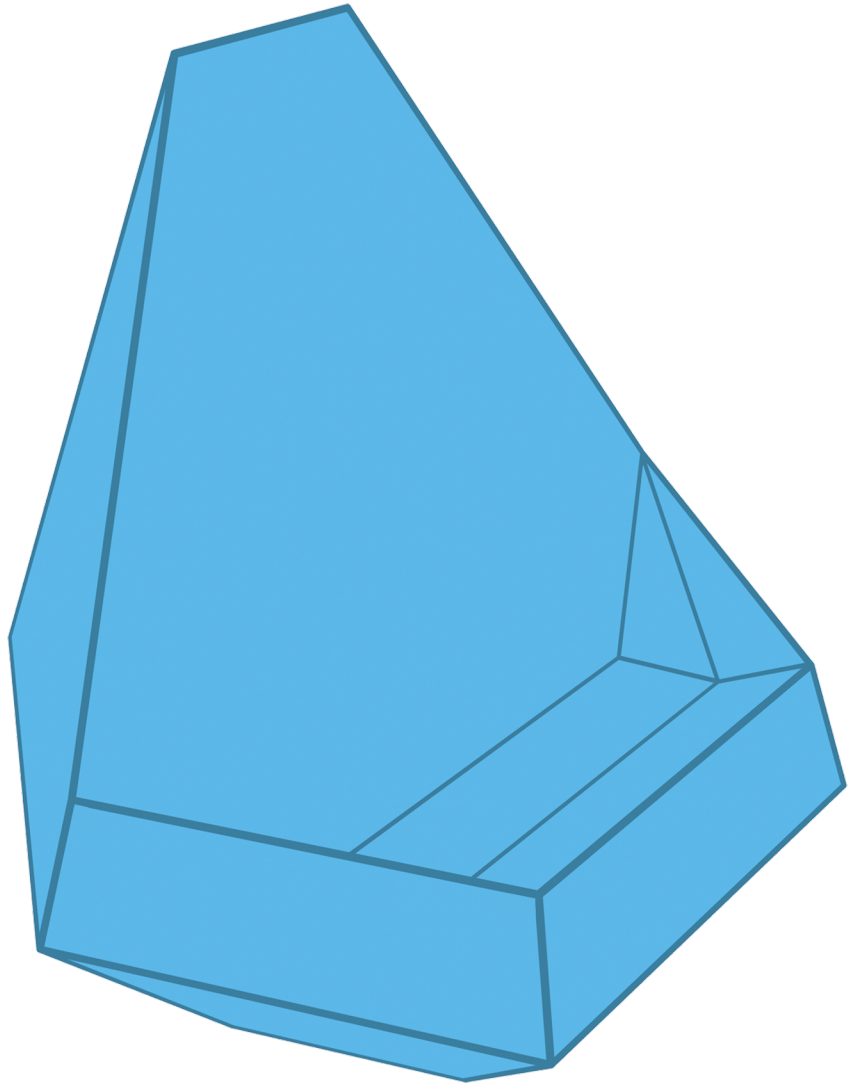
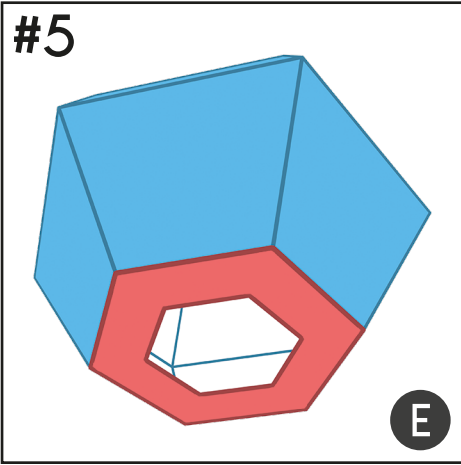
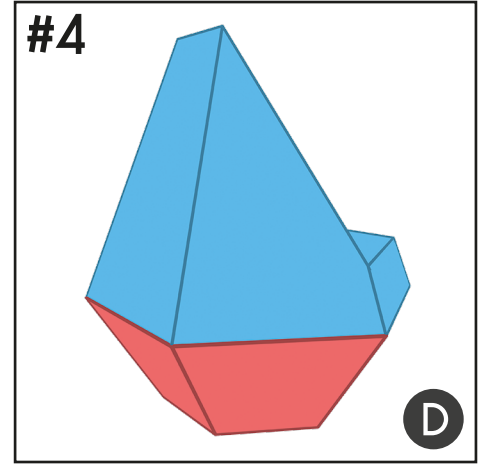
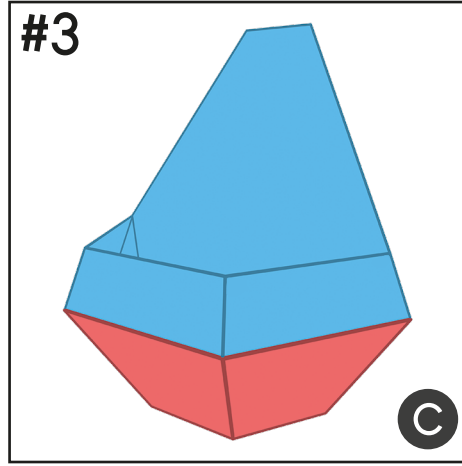
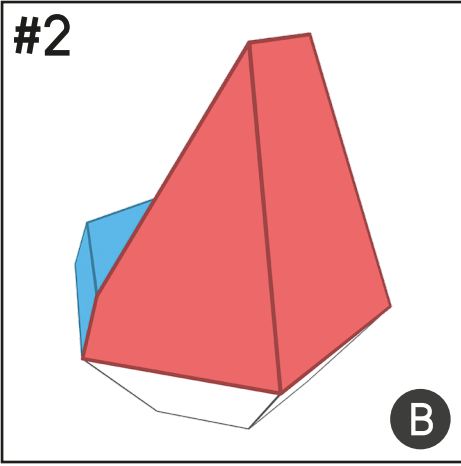

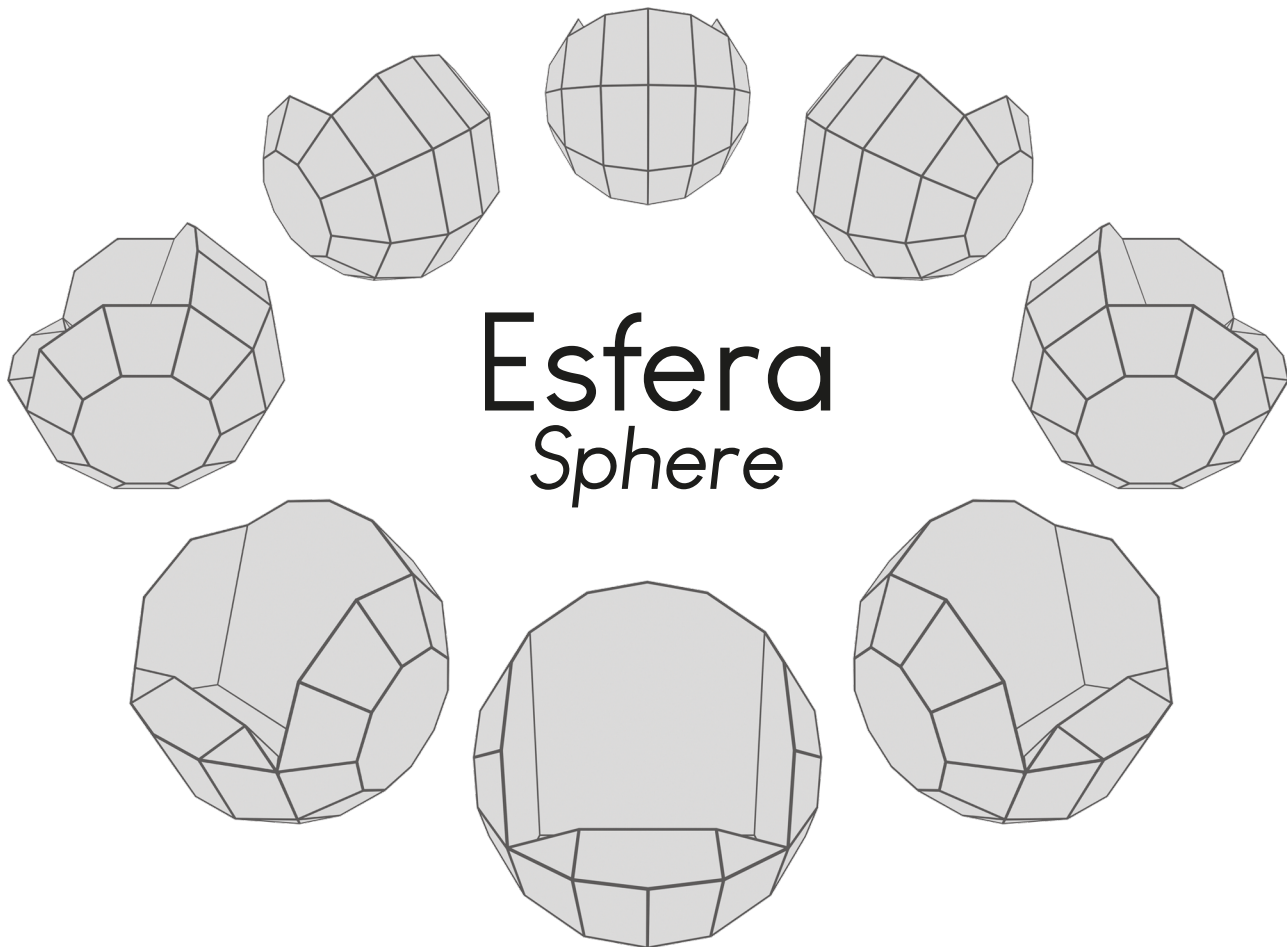

#1

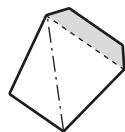
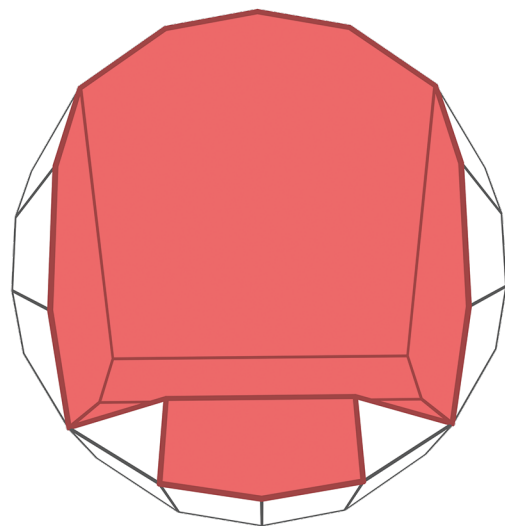
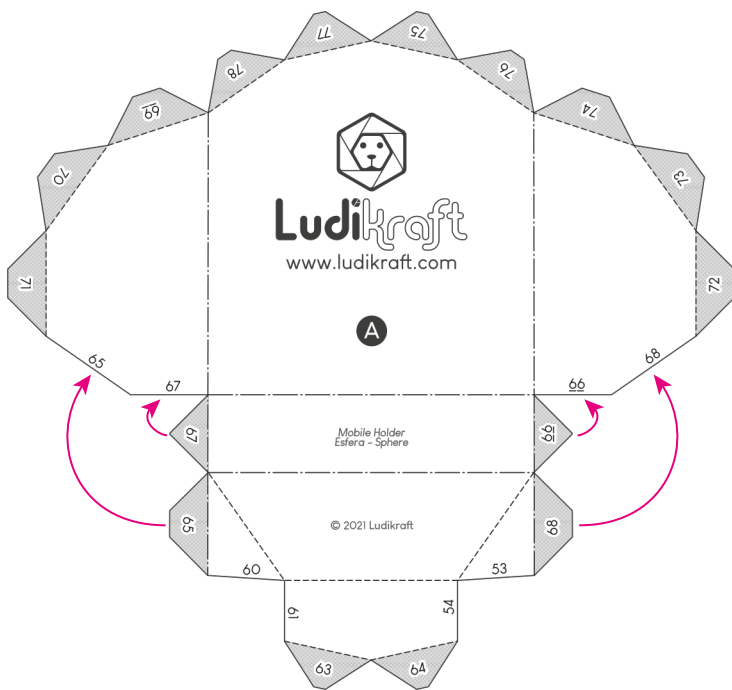

16 piezas - 16 pieces



1h



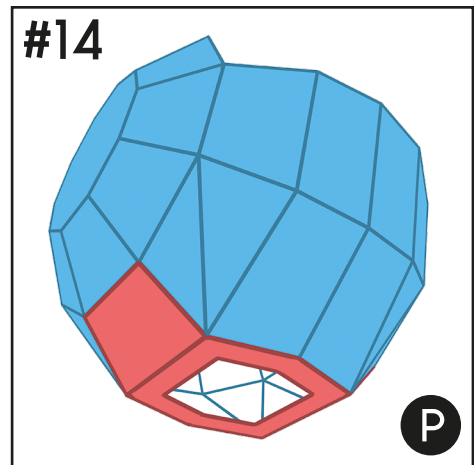
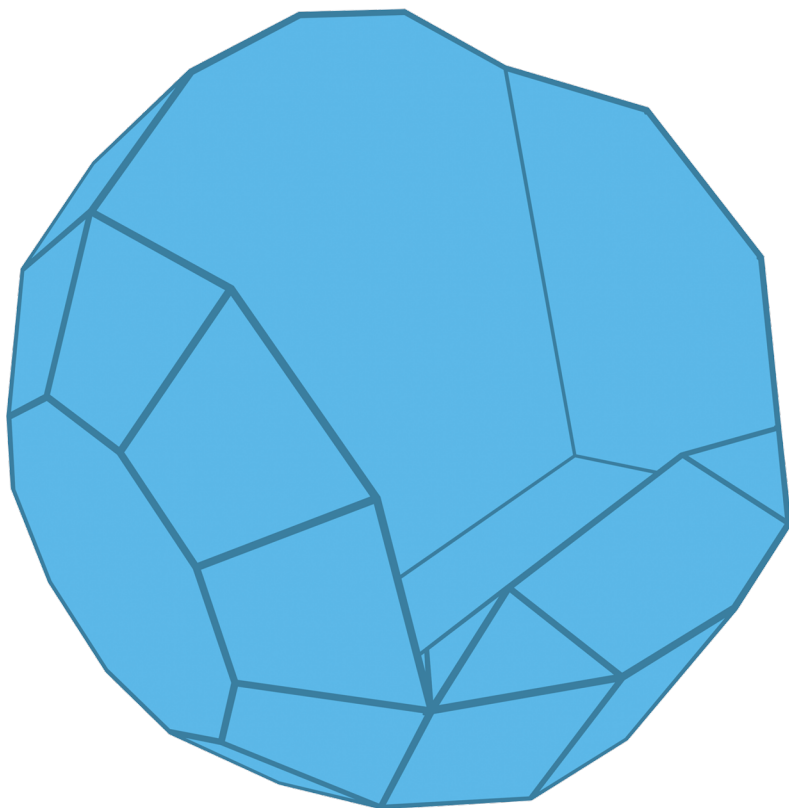
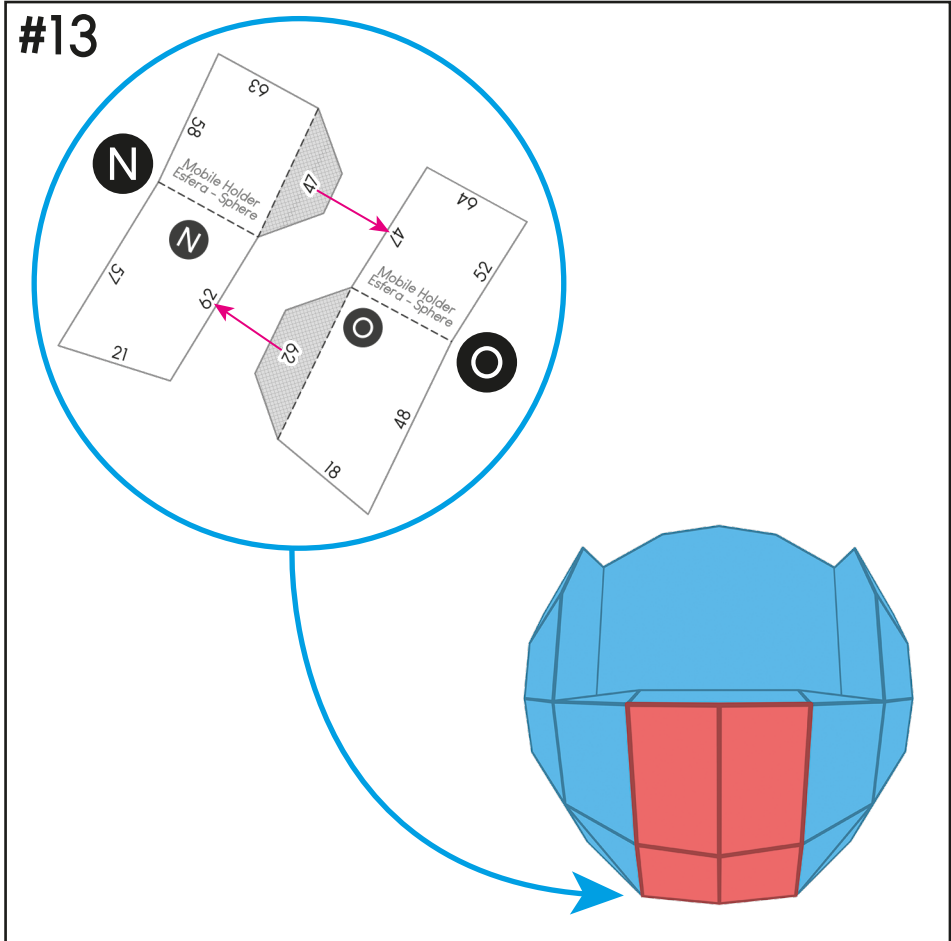
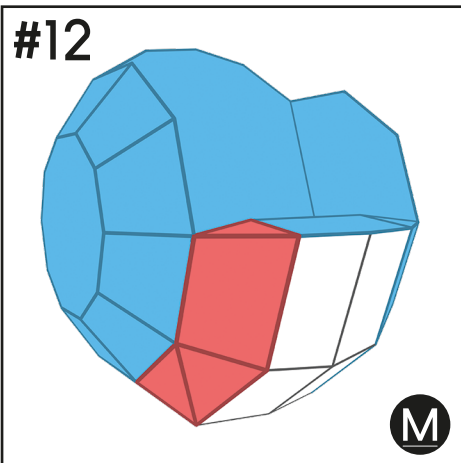
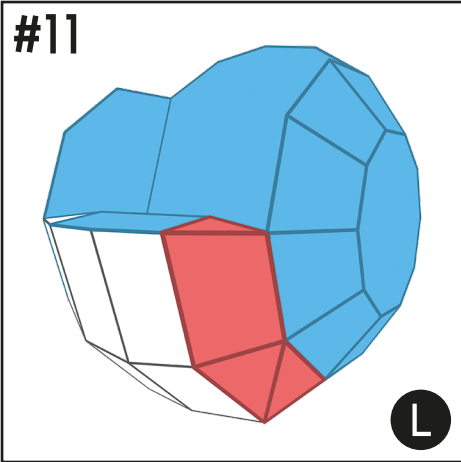

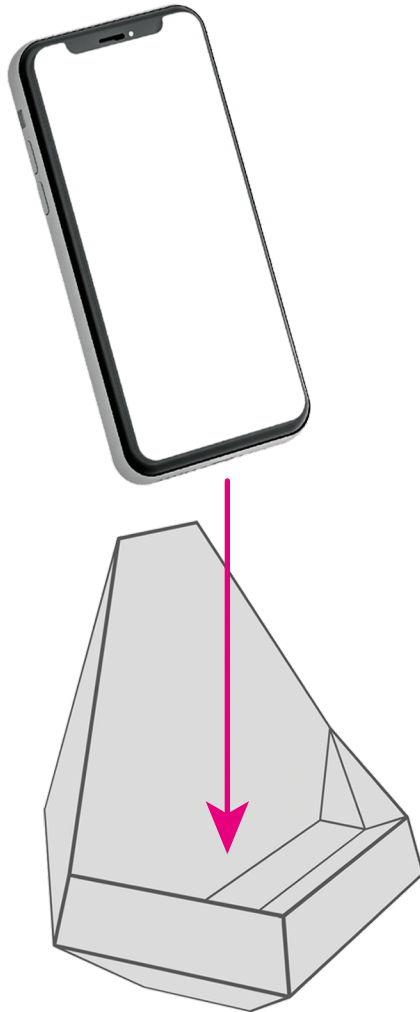

Si tienes algún problema, duda o inquietud sobre nuestros productos, revisa las preguntas frecuentes (FAQ) en nuestro sitio web [www.ludikraft.com](http://www.ludikraft.com) o comunícate a [info@ludikraft.com](mailto:info@ludikraft.com)  
WhatsApp (+57) 350 - 470 4836

If you have any problems or questions about our products, please check the frequently asked questions (FAQ) on our website [www.ludikraft.com](http://www.ludikraft.com) or contact [info@ludikraft.com](mailto:info@ludikraft.com)  
WhatsApp (+57) 350 - 470 4836



Nos encantaría ver tus modelos terminados. Por favor, compártelos en nuestra pagina de Facebook:

[www.facebook.com/Ludikraft](http://www.facebook.com/Ludikraft)

Puedes usar el hashtag **#ludikraft** o el handle **@ludikraft** en Instagram.

Éste y más productos también en:

[www.etsy.com/es/shop/Ludikraft](http://www.etsy.com/es/shop/Ludikraft)

Agradecemos tu preferencia con nuestros productos y esperamos que los disfrutes.

We would love to see your finished models. Please share them on our Facebook page:

[www.facebook.com/Ludikraft](http://www.facebook.com/Ludikraft)

You can use the hashtag **#ludikraft** or the handle **@ludikraft** on Instagram.

This one and more products also in:

[www.etsy.com/es/shop/Ludikraft](http://www.etsy.com/es/shop/Ludikraft)

Many thanks for your preference for our products and we hope you enjoy them.



Diseñado en Colombia  
Hecho en Colombia

Designed in Colombia  
Made in Colombia



**Ludikraft**